

Stainless Made Simple



EASTERN SCREW CO.

Domestics & Imports Together

ISO 9001:2015

www.easternscrew.com

*SIMPLIFY YOUR
STAINLESS PURCHASING
BY ACCESSING BOTH
IMPORTS AND DOMESTICS
WITH ONE PHONE CALL
AND A SINGLE PO.
SAVE TIME,
INCREASE BUYING POWER
& SERVICE YOUR
CUSTOMERS QUICKER WITH
EASTERN SCREW CO.*

Domestics—

- ▶ **Competitive on long- and short-run manufacturing**
- ▶ **One of the industry's largest inventories of hard-to-find stainless fasteners**
- ▶ **The industry's lowest minimum to manufacture (1000 pieces)**
- ▶ **1-2 week lead times available**
- ▶ **Blanket Release Programs available**
- ▶ **Same day shipment from stock**

**ROHS compliant
on demand**

Imports—

- ▶ **Competitive Pricing on 18-8, 316, and 410 stainless steel**
- ▶ **Stock in RI, MO, NC, TN, & IN**
- ▶ **Overseas mill quotes available**
- ▶ **Prepaid Freight: Min. 500 lbs., delivered by truck line**
- ▶ **Blanket Release Programs available**
- ▶ **Same day shipment from stock**

**Certificates of Compliance and Chemical Physical
Test Reports available**

Full Laboratory Reports upon request

**Ask about our volume
account incentives**

Precision Machine & Tool—

In addition to Eastern Screw's Domestic and Import capabilities, we have a fully staffed precision machine and tool center. A "job shop", capable of small "one-up" and longer runs. Our facilities list details our ability to perform precision drilling, turning, grinding, milling... virtually any required machining of special parts... from scratch, or to finish an existing piece.

We work with a broad variety of materials, including... Inconel, Monel, Hasteloy, Titanium, Stainless, Carbide Tool Steel, Brass, Bronze, Aluminum and Plastics. Eastern also manufactures and stocks a full line of Cold Headed Dies for Tooling and Supplies.

If you have on-going, or occasional machining requirements... let Eastern be your source.

Domestics —

OUR FOUNDER FIRST IMPACTED THE FASTENER INDUSTRY AS A MEMBER OF THE TEAM THAT DEVELOPED THE PHILLIPS HEAD DRIVE. THIS SAME INNOVATIVE SPIRIT SPARKED THE CREATION OF EASTERN SCREW, A COMPANY BUILT ON TWO BASIC PRINCIPLES: TO COMPETITIVELY MANUFACTURE THE HIGHEST QUALITY STAINLESS SCREWS AND PROVIDE AN EXPANSIVE INVENTORY OF HARD-TO-FIND STAINLESS ON THE SHELF. ALMOST 50 YEARS LATER, THESE COMMITMENTS STILL DEFINE OUR COMPANY.

Manufacturing Capabilities











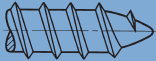
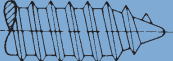
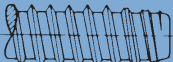

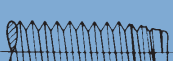
Diameter & Maximum Length	
Diameters	Maximum Length
#4	3"
#5	3"
#6	4 3/4"
#8	5"
#10	6"
#12	6"
#14	6"
1/4"	6"
5/16	4"
3/8	4"

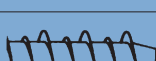
Highly competitive, long-run pricing!

Drives	
Phillips— Type 1, 1A	One-Way
Slotted	Tri-Wing
Hex Socket	Combo: Phillips/Square Socket
Square Recess	Combo: Slot/Square Socket
6 Lobe	Combo: Phillips/Slot
6 Lobe w/Pin NEW!	

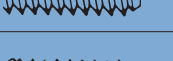
Head Styles		
Pan	Flat— 82°, 90°, 100°	Round Washer
Oval	Binding	Hex Washer
Round	Button NEW!	Indented Hex
Fillister	Cheese	Full Hex
Truss	Projection Weld Stud	Carriage Bolts
Pancake	Socket Cap Screws NEW!	Wafer

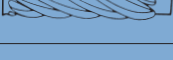
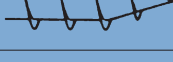
Screw Types

	ANSI/ASME Designation	Manufacturer's Designation
	A	A
	AB	AB
	B	B
	BF	BF
	BT	25
	C	C
	D	1
	F	F
 NEW!		Hi-Lo (B,A pts.)
	Machine Screw	Machine Screw
 NEW!	Cone Point	Cone Point
	Machine Screw Header Point	Machine Screw Header Point
	T	23
 NEW!	U	U
 NEW!		Vinyl Lock
	17	
 NEW!	Tek Screws	Self Drilling Screws

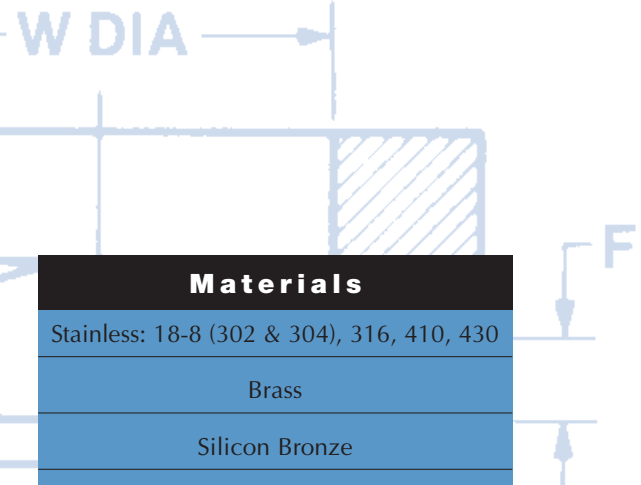

Materials

Stainless: 18-8 (302 & 304), 316, 410, 430

Brass

Silicon Bronze

Aluminum

Carbon Steel

Monel

Secondary Operations

Shank Slotting **NEW!**

Cut Downs **NEW!**

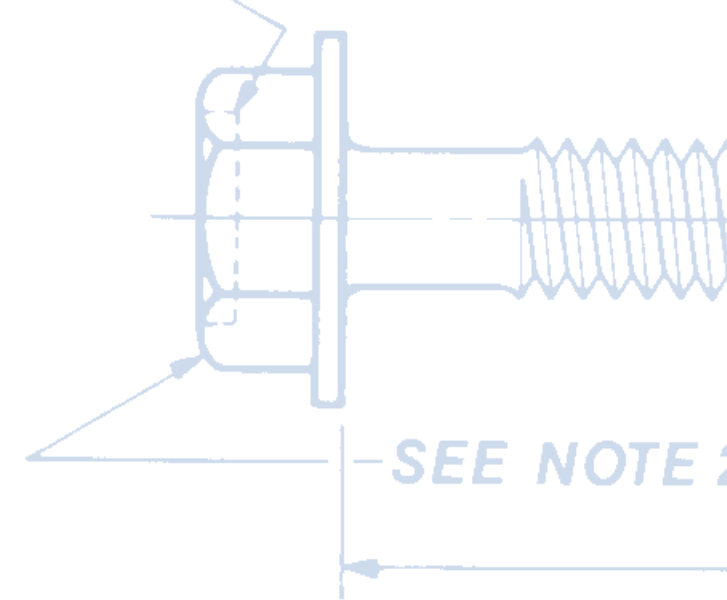

Also available to manufacture:

- ▶ Metric— ISO and DIN standard
- ▶ Left-hand thread machine screws

Imports—

TO EXPAND AND DIVERSIFY

OUR HARD-TO-FIND

DOMESTIC INVENTORY, WE HAVE

ACQUIRED FASTENER XCHANGE.

RHODE ISLAND, MISSOURI,

TENNESSEE, NORTH CAROLINA,

and Indiana, ALL LOCATIONS

OFFER **COMPETITIVELY PRICED**

STANDARD STAINLESS IMPORTS

WITH SAME DAY SHIPMENT*

AND EXCEPTIONAL SERVICE.

Approx. Shipping Weights/1000pcs. 18-8ss

Conversions:

316ss +1%

Brass +8%

Sil. Bronze +12%

410ss & Steel:

Same as 18-8

Hex Head Cap Screws									
	1/4	5/16	3/8	7/16	1/2	5/8	3/4	7/8	1
1/2	13.6	21.4	33.6						
3/4	15.9	25.6	39.6	56.0	84.2				
1	19.0	29.8	45.8	64.2	95.6	157	244		
1 1/4	21.8	35.3	52.6	78.5	107	174	269		
1 1/2	25.6	40.5	60.4	83.4	119	192	294	443	616
1 3/4	29.1	46.0	68.4	93.0	133	212	321	474	660
2	32.4	51.3	76.0	104	147	234	349	514	696
2 1/4	36.0	56.8	83.6	115	161	255	380	532	740
2 1/2	39.4	62.0	94.5	125	174	277	412	590	796
2 3/4	43.1	67.9	99.2	136	188	300	443	619	854
3	46.2	73.3	107	147	202	320	475	687	918
3 1/4	49.9	78.7	114	157	215	341	506	708	964
3 1/2	53.0	84.1	123	168	229	362	536	768	1021
3 3/4	56.8	89.4	130	178	243	384	567	792	1078
4	60.0	94.9	137	189	257	406	605	855	1154
4 1/2	63.7	106	153	210	284	449	660	938	1242
5	74.1	116	169	231	312	492	736	992	1371
5 1/2	80.8	127	184	253	340	535	780	1075	1464
6	88.0	138	200	273	367	578	862	1194	1594

Carriage Bolts				
	1/4	5/16	3/8	1/2
1/2	12.5			
3/4	14.4	24.1	36.1	
1	17.1	29.1	43.2	88.1
1 1/4	20.2	34.0	51.4	101
1 1/2	23.2	39.3	57.2	114
1 3/4	27.3	44.0	63.0	127
2	30.4	48.2	72.1	138
2 1/2	36.5	58.1	85.9	163
3	43.7	67.1	101	188
3 1/2	49.4	78.0	115	216
4	57.0	86.2	131	238
4 1/2	62.6	96.4	144	265
5	69.2	111	160	291
5 1/2	72.0	117	174	318
6	84.0	127	187	341

Lag Bolts				
	1/4	5/16	3/8	1/2
1	17.1	29.1	39.4	
1 1/4	19.8	33.6	47.8	103
1 1/2	22.6	37.2	54.6	114
1 3/4	25.8	42.9	60.1	127
2	28.4	46.1	66.8	138
2 1/2	35.0	55.4	79.8	162
3	40.1	64.3	92.0	183
3 1/2	44.2	73.4	104.9	209
4	51.0	82.0	117.1	230
4 1/2	56.6	91.6	130.1	254
5	63.2	100	141.8	278
6	75.8	118	167.1	324

* For items in stock. Orders must be placed by 3:00 PM EST for same day shipment.

Machine Screws									
	2	4	6	8	10	12	1/4	5/16	3/8
1/4	.5	.9	1.6	2.4	3.8				
3/8	.6	1.1	1.9	3.0	4.4	6.0	8.6		
1/2	.8	1.4	2.3	3.7	5.0	7.0	10.4	18.9	29.1
5/8	.9	1.6	2.7	4.2	5.8	7.9	11.8	20.5	31.4
3/4	1.1	1.9	3.0	4.7	6.7	8.9	12.4	23.1	34.5
1	1.4	2.3	3.8	5.8	8.0	11.0	15.7	26.0	40.6
1 1/4		2.8	4.5	6.9	9.3	12.7	18.0	30.1	46.6
1 1/2		3.3	5.3	8.0	11.0	14.6	20.2	34.8	52.8
1 3/4		3.7	6.0	9.1	12.2	16.6	23.2	40.0	59.0
2		4.3	6.7	10.3	13.6	18.6	25.6	44.0	65.0
2 1/2		5.5	8.2	12.5	16.5	22.5	30.9	51.1	77.3
3		6.5	9.8	14.7	19.4	26.2	36.0	60.0	89.1
3 1/2			11.5	17.5	22.6	29.2	41.3	68.6	103.0
4			13.0	20.0	25.0	33.8	48.0	76.7	115.0
4 1/2			14.5	23.0	28.0	37.3	54.0	84.5	127.2
5				26.5	31.0	41.8	60.0		
5 1/2				29.5	34.0	45.3	66.5		
6				32.5	37.0	49.0	73.0		

Sheet Metal Screws									
	2	4	6	8	10	12	1/4	5/16	3/8
1/4	.5	.8	1.5	2.3					
3/8	.6	1.1	1.7	2.6	3.9				
1/2	.7	1.4	2.3	2.9	4.3	6.0	8.9		
5/8		1.6	2.4	3.6	5.1	7.1	10.0		
3/4		2.0	2.8	4.1	5.8	8.1	10.9	21.0	34.4
1		2.2	3.4	4.8	6.5	9.2	13.1	25.0	40.2
1 1/4		2.7	4.1	6.1	8.0	11.5	15.7	28.0	46.0
1 1/2		3.1	4.7	7.0	9.4	12.5	16.9	34.1	52.0
1 3/4		3.6	5.4	7.9	10.4	14.3	20.0	38.6	58.1
2		4.1	6.2	8.7	11.8	16.2	21.6	42.0	64.2
2 1/2		5.4	8.0	10.6	14.0	19.2	25.9	50.1	76.1
3		6.4	9.5	12.1	16.8	22.6	30.0	59.0	88.0
3 1/2			11.0	17.0	22.5	28.0	38.0	67.5	101.9
4			12.6	19.2	25.0	32.5	45.2	73.0	114.0
4 1/2			14.0	22.0	27.6	37.0	52.0		
5				25.4	30.0	41.0	58.5		
5 1/2				29.0	33.0	44.0	64.3		
6				31.8	36.0	47.0	71.0		

Socket Cap Screws**									
	2	4	6	8	10	1/4	5/16	3/8	1/2
3/16	.4	.9							
1/4	.5	.9	2.1	3.1					
3/8	.7	1.1	2.6	3.6	5.6	10.0	17.0		
1/2	.8	1.4	3.0	4.4	6.4	11.1	19.2	32.5	72.2
5/8	1.1	1.8	3.3	4.9	7.0	12.8	21.4	35.2	78.1
3/4	1.4	2.1	3.8	5.6	7.8	14.2	23.5	38.1	80.7
1	1.6	2.7	4.6	6.9	10.0	16.2	27.4	44.0	92.3
1 1/4	2.2	3.0	5.7	8.1	11.6	18.5	33.1	50.7	101
1 1/2		3.6	6.6	9.0	13.3	22.5	37.2	60.4	112
1 3/4		4.0	7.9	10.7	15.4	23.8	42.8	67.4	132
2		4.8	8.7	11.8	15.6	26.2	47.4	76.1	144
2 1/2					19.4	31.1	57.2	91.7	173
3					24.8	36.2	69.1	108	196

Socket Set Screws**									
	2	4	6	8	10	1/4	5/16	3/8	1/2
3/16	.21	.3	.5	.7	.84	1.4			
1/4	.23	.44	.6	.9	1.1	1.8	2.6	3.7	
3/8	.44	.53	1.1	1.7	2.0	3.2	5.0	6.2	11.2
1/2	.70	.9	1.4	2.1	2.5	4.2	7.1	9.6	16.3
5/8		1.2	1.8	2.6	3.0	5.8	9.2	12.3	21.8
3/4		1.5	2.1	3.4	4.0	7.0	11.1	17.2	26.4
1			2.9	4.7	5.4	9.4	15.2	22.0	36.7
1 1/4						12.0	19.7	27.0	49.8
1 1/2						15.0	24.2	33.0	61.2
1 3/4						17.1	28.1	40.4	76.0
2						19.6	32.3	46.3	81.1

Nuts							
	m/s fin	Jam	Nyl. /L/N	Cap	Heavy	Square	Wing
2	.42						
4	1.2		1.3	2.5			
6	2		2.5	4.4		2.5	4.2
8	2.9		3.9	5.0		3.3	7.8
10	3.5		5.0	7.0		4.0	7.8
12	5.4		8.6				
1/4	7.1	5.3	8.9	13.1	12.2	7.5	14.0
5/16	10.5	7.5	10.8	24.6	20.1		17.8
3/8	15.1	10.1	17.5	35.1	32.0		30.0
7/16	27.4	18.6	28.9		47.1		71.3
1/2	35.8	26.0	42.2	61.2	67.0		77.2
5/8	68.8	48.4	86.3	109	119		129
3/4	127	85.9	122		193		
7/8	198	131	194		293		
1	294		259				

Washers			
	Flat	Med. Lock	Finish Cup
2	.2	.1	
4	.4	.2	.5
6	.5	.3	.7
8	.8	.6	1.0
10	1.2	.8	1.3
12	1.8	1.2	1.8
1/4	3.4	2.6	2.1
5/16	5.2	4.4	
3/8	8.4	7.1	
7/16	16.2	10	
1/2	23.4	15.2	
5/8	34.2	25.9	
3/4	67.9	43.0	
7/8	74.2	67.2	
1	97.1	96.8	

** Weights for sockets provided for your convenience. Our current socket inventory is minimal.

Quality:



ISO 9001:2015

Both manufacturing and distribution divisions are certified to the ISO 9001:2015 quality management system. This standard provides the guidelines for performance improvement tools we have in place that ultimately generate value to the customer. The 2015 revision of the ISO 9000 standard focuses on continuous improvement through a process-based approach. Strict quality procedures are in place assuring the integrity of product to the highest quality standard possible, with traceability back to the original raw material, available to our customers upon request.

RoHS Compliance:

Working with our world wide partners to protect the environment, we provide and certify a large part of our inventory to RoHS demands (European Directive 2002/95/EC). RoHS (Restriction of Hazardous Substances) is a directive requiring all electrical or electronic equipment sold after 2006 satisfy strict regulations limiting the presence of several hazardous materials in products so as to be virtually contaminant free if/when disposed of. This regulation has been adopted by China and most European countries, and the United States is currently working on similar legislation for domestic restrictions as well.

EASTERN SCREW CO.

Corporate Headquarters: 15 Amflex Drive, Cranston, Rhode Island 02921
www.easternscrew.com • sales@easternscrew.com

Domestics—

Manufacturing & Stock in RI

Imports—

Stock in RI, MO, TN, NC, IN

1-800-USA-ESCO (872-3726)

FAX: 401-942-7810